



Backpack Sprayer

Use and Care Manual



⚠ CAUTION: Read and follow all instructions

Do Not Return This Sprayer To The Store
For Help, Information or Parts, Call : 1-800-311-9903

The Fountainhead Group, Inc.

23 Garden St., New York Mills, NY 13417

1-800-311-9903

www.TheFountainheadGroup.com



The
Fountainhead
Group, Inc.

Manual No. 181702
Rev A. 10/2010

SAFETY PRECAUTIONS

- Read owner's manual completely before operating this sprayer.
- Always use goggles, gloves, and protective clothing when using sprayer.
- Read and follow all instructions and cautions on label of products used in this sprayer.
- Never use flammable liquids, caustics, acids, or hot water in this tank.
- Do not leave sprayer in the sun when not in use.
- Spray when air is calm to prevent drift of chemicals.
- Do not use sprayer near open flame or anything that could cause ignition of the spray.
- Always inspect hose and all hose connections before each use. A damaged hose, or loose hose connection can result in unintended exposure to the pressurized chemical, resulting in serious injury or property damage.
- Do not lift or carry sprayer by the hose, shutoff valve, or wand extension. Carry by the handle only.
- Do not pressurize with any mechanical device such as an air compressor, since this can create a dangerous pressure level and bursting of parts resulting in serious injury. Only use original pump.
- Do not store chemicals in this tank.
- Always release pressure when sprayer is not in use and before performing any maintenance.
- Clean and rinse sprayer thoroughly after each use.
- Never attempt to alter sprayer from original condition.
- Always use replacement parts from original manufacturer.
- Keep the sprayer and all chemicals out of the reach of children.

CAUTION

Always empty, clean and dry tank, pump system, shut-off, hose, and extension after each use. Failure to do so may weaken sprayer components causing components to rupture when pressurized. Failure to clean and properly maintain your sprayer will void manufacturer's warranty.

WARNING

The sprayer is operated with liquid under pressure. Failure to observe caution and to follow instructions for operating and cleaning can cause tank, hose and other parts to be weakened and rupture under pressure. This can result in serious injury from high pressure discharge of liquids or forcible ejection of parts. Do not use flammable materials in this sprayer. Material could ignite or explode, causing serious injury and/or possible death. For safe use of this product, you must read and follow all instructions before use.

TEST SPRAYER WITH WATER BEFORE USING ANY CHEMICALS.

LIMITED WARRANTY

We warrant that each product sold by us will be free from defects in material and workmanship for a period of five years from the date of shipment by us. We make no other express warranties, and all implied warranties, including fitness and merchantability, are limited to five years from the date of shipment by us. Within the warranty period, we will repair or replace any part found to be defective upon our examination but will not pay shipping cost or other expenses. To obtain warranty service, contact us at: The Fountainhead Group, Inc., c/o Customer Service, 23 Garden Street, New York Mills, New York 13417, or (315) 736-0037 or call toll free, (800) 311-9903. Merchandise may not be returned without prior permission and must be returned to us, not the store, prepaid. This warranty service is an exclusive remedy and we are not responsible for any consequential or incidental damages or injury to person(s) or property. This warranty shall not apply to any product which has been subject to misuse, negligence or accident, or been damaged in shipment, or misapplied, or which has been modified or repaired by unauthorized persons. This warranty only applies to products owned by persons purchasing directly from us or from our approved distributors and merchandisers. The right is reserved to incorporate subsequent design or parts changes after publication and without reissue of descriptive literature or catalogs.

NOTE: Limitations on duration of implied warranty and/or consequential damages might not apply to you if your state does not permit them. This warranty gives you specific legal rights in addition to rights you may have under state law.

ASSEMBLY INSTRUCTIONS

Assemble Extension, Shut-Off, Nozzle and Spray Optimizer

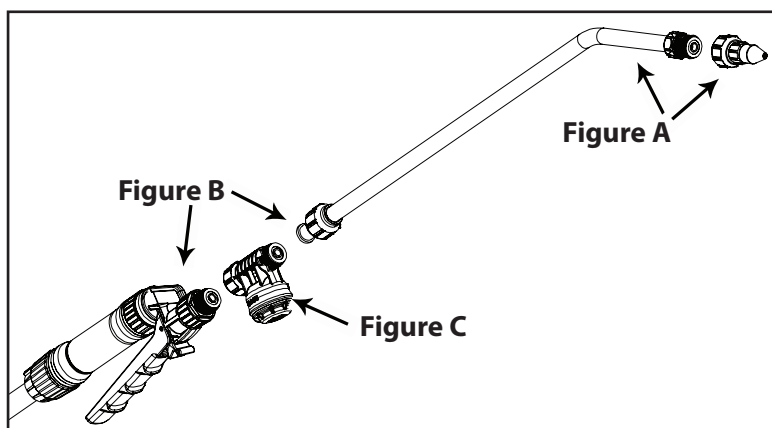

1. Install selected nozzle onto the end of the extension and tighten securely. **Figure A**
2. Install the extension "wand" onto the shut-off assembly and tighten the nut securely. **Figure B**
3. Install Spray Optimizer for low pressure (low drift) applications. This will help prevent weed killer formulas from drifting into undesired areas. (**Do not over tighten, actual position will vary**). **Figure C**

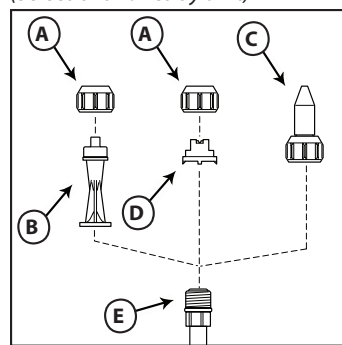

SELECT USING NOZZLE CHART BELOW
(Selections varies by unit)



- A. Cap Nut
B. Foaming Nozzle
C. Adjustable Cone Nozzle
D. Fan Nozzle
E. Extension

ADJUSTABLE CONE USES:	FAN NOZZLE USES:	FOAMING NOZZLE USES: (for use with Roundup® products only)
 <ul style="list-style-type: none"> • Spot spraying in or around flower beds, trees, and shrubs. • Edging along fences, driveways, and walkways. • Killing brush such as poison ivy, poison oak, kudzu and wild blackberry. • Preparing garden beds for planting of ornamentals and vegetables. 	 <ul style="list-style-type: none"> • Lawn replacement. Kill lawn and weeds before planting a new lawn. • Preparing large areas for planting of ornamental and vegetable gardens. 	 <ul style="list-style-type: none"> • Spot spraying in flower beds, walkways, driveways, and patios, around trees and shrubs. • Edging along fences, driveways and walkways. • Killing brush such as poison ivy, poison oak, kudzu and wild blackberry.

Assemble Pump Handle

1. Determine which hand will be used to actuate the pump during normal use (there is a left and right connector).
2. Slide pump handle on the pump connector at the base of sprayer. Ready for use. **Figure D**

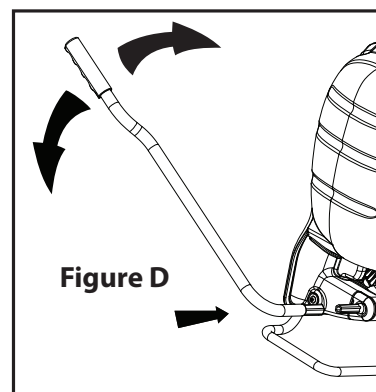

OPERATING INSTRUCTIONS

Always conduct a test using cool, clean water before mixing chemicals.

Filling

Always refer to chemical manufacturer for proper mixture.

1. Remove the cap from the tank.
2. Make sure the filter basket is in place in the neck of the tank.
3. Fill the tank with cool water and chemical to the desired level.
4. Reinstall the cap.

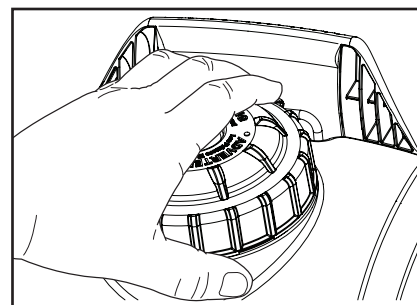

Pressurizing and Spraying

1. To begin pressurizing, be sure shut-off lever is not depressed. Pump handle up and down in a smooth motion **Figure D**. Operating pressure is reached when pumping becomes difficult, which is no more than 5-7 full pumps. (**Do not over-pressurize**)
2. Direct nozzle away from you and squeeze shut-off handle to begin spraying.

Pressurizing and Spraying con't

- To maintain pressure while spraying, operate pump handle every 8 sec. or as needed.
- For continuous spraying, squeeze handle and rotate lock. **Figure E**
- Unlock if needed and release shut-off handle to stop spraying.

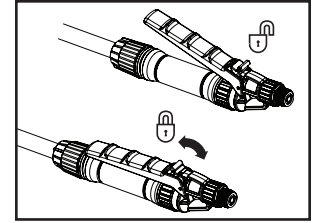

Figure E

Cleaning

- Fill the tank with cool, clean tap water. Replace the cap and tighten securely. (**Never use hot water for cleaning**)
- Agitate the tank to rinse the chemical from the tank walls.
- Remove the cap and empty the contents into gravel or bare soil.
- Refill the tank with clean tap water. Replace the cap and tighten securely.
- Pressurize the tank as described in the *Pressurizing and Spraying* section.
- Direct the nozzle away from you and squeeze the shut-off handle for at least 30 seconds to clean the pressure chamber, hose and shut-off.
- Remove the cap and empty the contents into gravel or bare soil.
- Repeat steps 4 - 7 until thoroughly cleaned. Remove nozzle when flushing pump system. Clean nozzle before replacing.

Sprayer Storage

- Never store sprayer with pressure in chamber or liquid in any part of sprayer.
- Sprayer tank should be hung upside down, with the cap removed, to dry completely.
- Do not store or leave any solution in the tank after use.
- Store in a warm, dry location out of direct sunlight.
- Keep the sprayer and all chemicals out of the reach of children.**
- Remove pump handle, rotate 1/4 turn, and reinstall to store handle in upright position.

MAINTENANCE

Tank Maintenance

- After each use, rinse the tank with cool, clean water.
- Check the check valve (**Figure F**) and filter basket gasket. (**Figure G**)
Make sure they do not show signs of wear and are operating properly. Replace them as required.
- Clean any dirt or debris from the filter basket.
- Periodically check the straps for fraying. Replace them as required.

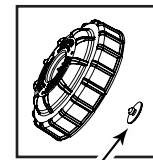

Figure F

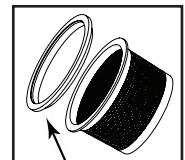
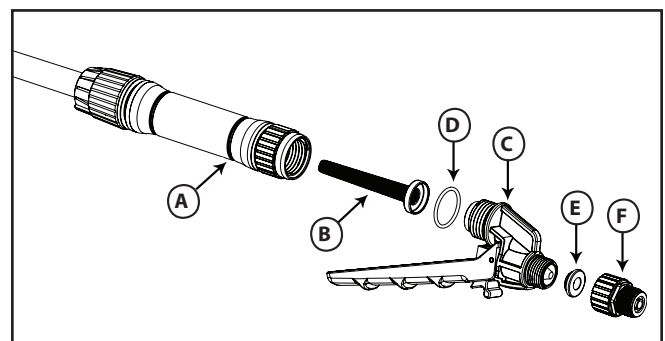

Figure G

Shut-off Maintenance (Smith Pro)

Always depressurize sprayer before maintenance by activating shut-off and spraying contents out.

- Unscrew the handle from the shut-off assembly.
- Unscrew the seal cap from the shut-off assembly.
- Remove the filter from the shut-off assembly.
- Clean any debris from inside the handle and shut-off assembly, on the valve seat or the filter.
- Reassemble the components as shown and tighten all connections securely.



A. Handle

B. Filter

C. Shut-off Assembly

D. Washer

E. Valve Seat

F. Seal Cap

Nozzle Maintenance

1. If nozzle clogs, remove and disassemble the nozzle assembly.
2. Clean the openings of any obstructions and reassemble.

Pressure Chamber Maintenance

WARNING: Always depressurize sprayer before cleaning or replacing pressure chamber by activating shut-off and spraying out all pressure.

1. Remove the tank cap and strainer.
2. Reach into the tank and turn the chamber 1/4 turn counterclockwise to unlock the chamber from the pump then remove chamber from tank.
3. Rinse out any debris that may have accumulated in the chamber.
4. Reinstall the chamber into the pump by aligning the tabs on the chamber with the slots in the pump, push firmly into pump and turn clockwise until pump stops.
5. Reinstall the strainer and tank cap.

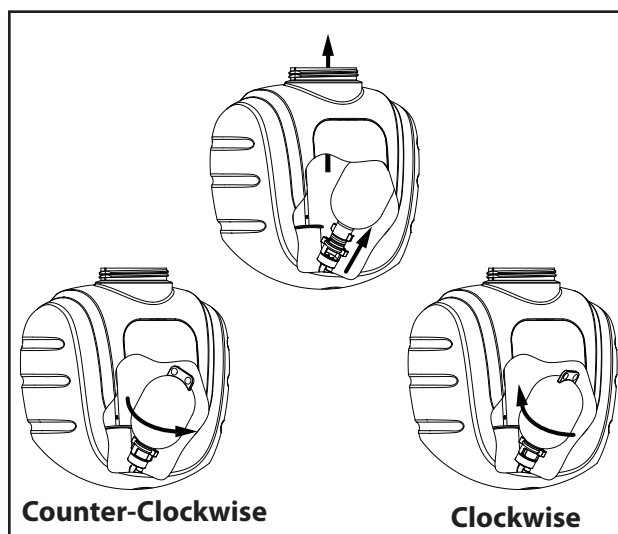

SERVICING INSTRUCTIONS

Prior to servicing and/or repairs.

1. Empty contents of tank.
2. While squeezing shut-off, pump sprayer until all liquid is expelled.
3. Continue squeezing shut-off without pumping to release all air pressure.
4. You will find all parts for servicing to be included in **KIT# 38**.

Tank Servicing Steps

1. Unscrew cap from tank. Remove and replace check valve. (**Figure 1**)
2. Remove pressure chamber as outlined in *Pressure Chamber Maintenance* section of the manual. Remove and replace o-ring. Lubricate o-ring with petroleum jelly. (**Figure 2**)
3. Unsnap agitator from piston rod. Remove from tank. (**Figure 3**)



Figure 1



Figure 2

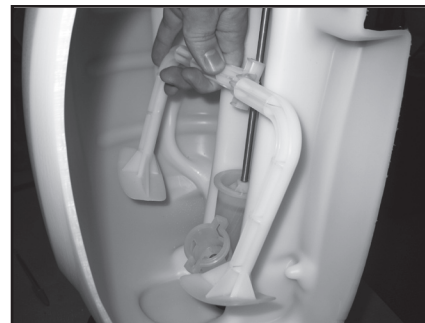

Figure 3

SERVICING INSTRUCTIONS CON'T

4. Position pump handle to the furthest downward position.
Remove pump handle from sprayer. **(Figure 4)**
5. Disassemble carry handle by removing the (6) screws. **(Figure 5)**
6. Remove hitch pin and lift pivot clip off of the piston rod. **(Figure 6)**



Figure 4

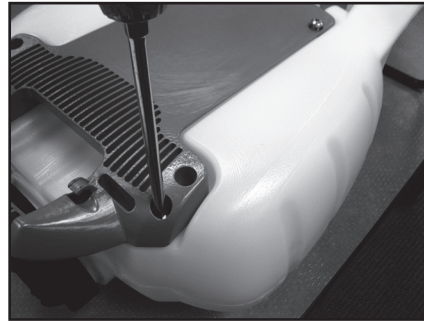

Figure 5



Figure 6

7. Pull upward to slide piston rod out of pump. **(Figure 7)**
8. While holding onto the pump, use an adjustable wrench to unthread pump nut from pump.
Remove nut, hose and barb assembly. **(Figure 8)**
9. Loosen hose clamp and pull hose off of barb. Remove barb from nut. **(Figure 9)**

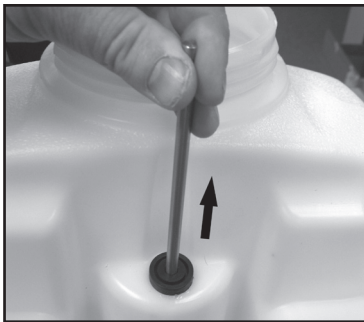

Figure 7

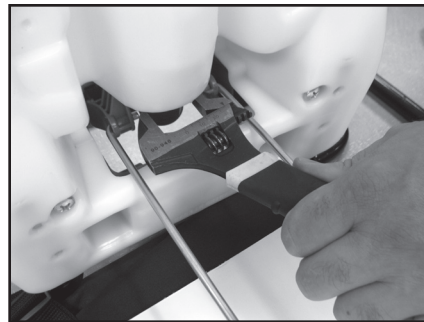

Figure 8

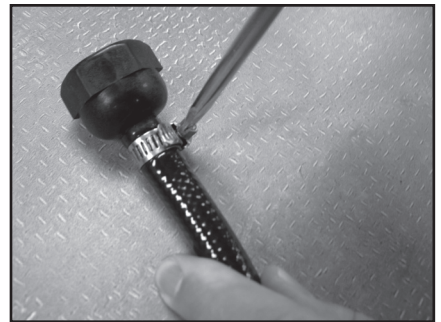

Figure 9

10. Carefully remove and replace (2) o-rings. Lubricate both o-rings with petroleum jelly. **(Figure 10)**
Reassemble barb, nut and hose and tighten hose clamp until secure.
11. Remove pump out of tank. Remove and replace gasket. **(Figure 11)**
12. Slide piston rod assembly down and out of grommet and remove from tank. **(Figure 12)**

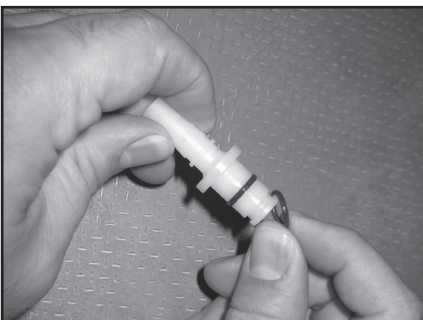

Figure 10

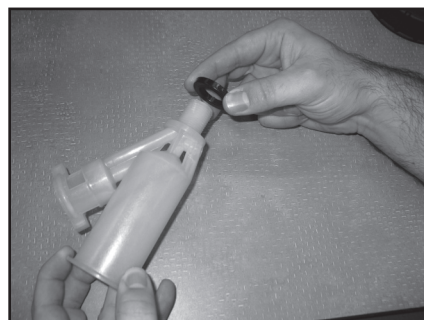

Figure 11



Figure 12

13. Carefully remove and replace o-ring from piston. Lubricate o-ring with petroleum jelly. **(Figure 13)**
14. Remove grommet from tank using pliers to grasp the head of the grommet while flexing the grommet out of the hole in the tank. Press or tap new grommet into tank. Lubricate hole in grommet with petroleum jelly. **(Figure 14)**
15. Insert piston rod assembly into tank and through grommet. **(Figure 15)**

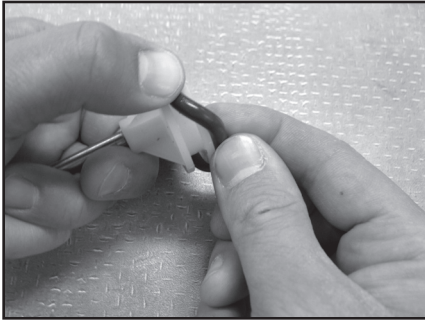

Figure 13



Figure 14



Figure 15

16. Reassemble pump with gasket into tank. See **(Figure 16)** for correct orientation. Tighten pump nut securely with adjustable wrench while holding pump to maintain correct orientation.
17. Push piston assembly into pump. Attach pivot clip to piston rod and insert hitch pin. Note orientation of piston rod must match the pivot clip. **(Figure 17)**
18. Reassemble carry handle onto tank. Tighten all (6) screws. **(Figure 5)**

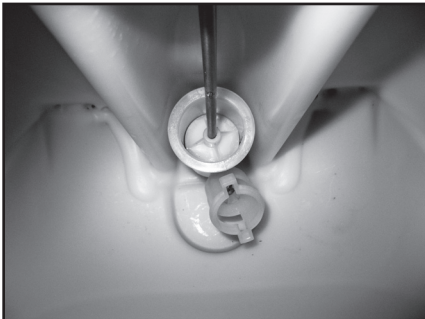

Figure 16



Figure 17



Figure 18

19. To reinstall the agitator, line the notch up on the agitator with the swedge on piston rod and snap into place. **(Figure 18)**
20. Reinstall pressure chamber as outlined in the *Pressure Chamber Maintenance* section. See **(Figure 19)**.
21. Replace tank cap, filter and pump lever. **(Figure 20)**

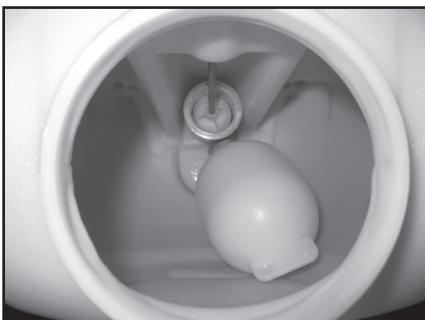

Figure 19

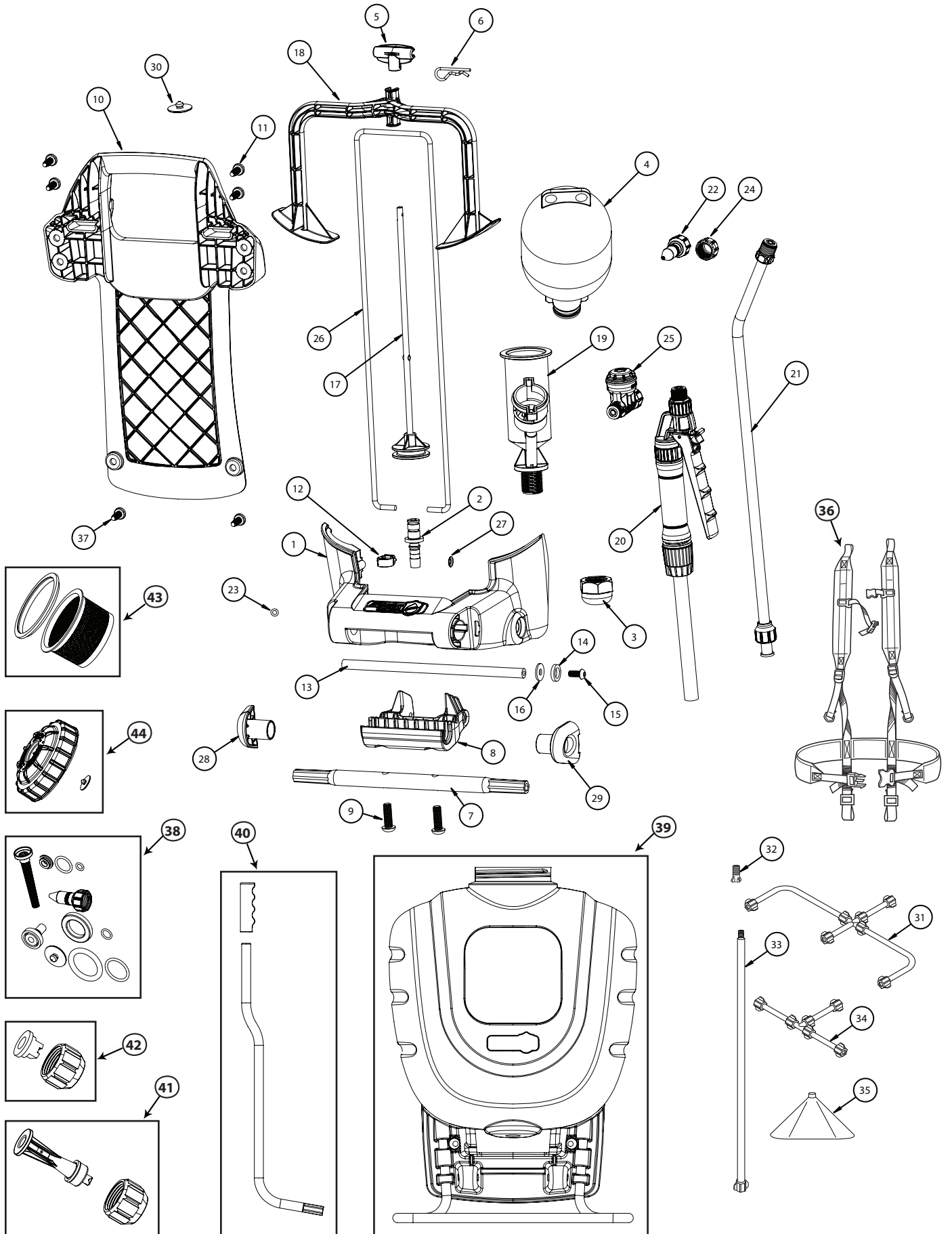

Figure 20

TROUBLE SHOOTING

TROUBLE	LOOK FOR	REMEDY
Sprayer starts to spray when pumping or sprayer will not stop spraying when shut-off lever is released.	Shut-off lock is engaged.	Squeeze shut-off handle and disengage the lock. See <i>Pressurizing and Spraying</i> section.
Sprayer will not build pressure.	<ol style="list-style-type: none"> 1. Pressure chamber installed into pump (# 4). 2. Dirty, damaged or worn pump or chamber o-ring (# 38). 3. Dirty check ball in pump. 	<ol style="list-style-type: none"> 1. Install pressure chamber as described in <i>Pressure Chamber Maintenance</i> section. 2. Clean and lubricate or replace o-rings as described in <i>Servicing</i> section. 3. Clean sprayer as described in <i>Cleaning</i> section.
Sprayer will not spray.	<ol style="list-style-type: none"> 1. Sprayer pressurization. 2. Shutoff clogged. 3. Nozzle clogged. 	<ol style="list-style-type: none"> 1. Pressurize sprayer as described in <i>Pressurizing and Spraying</i> section. 2. Clean shut-off as described in <i>Shut-off Maintenance</i> section. 3. Clean nozzle as described in <i>Nozzle Maintenance</i> section.
Sprayer leaks from the bottom of the tank.	<ol style="list-style-type: none"> 1. Loose pump nut (# 3). 2. Damaged or worn o-rings or seals (# 38). 	<ol style="list-style-type: none"> 1. Tighten pump nut as described in <i>Servicing</i> section. 2. Replace o-rings and seals as described in <i>Servicing</i> section.
Sprayer leaks where piston rod enters top of the tank.	Dirty, damaged, or worn grommet (# 38).	Clean and lubricate hole in grommet or replace grommet as described in <i>Servicing</i> section
Hose leaks at tank connection.	<ol style="list-style-type: none"> 1. Loose hose clamp (# 12). 2. Cracked, swollen or faulty hose. 	<ol style="list-style-type: none"> 1. Tighten hose clamp. 2. Replace shut-off assembly.
Hose leaks at shut-off.	Cracked, swollen or faulty hose.	Replace shut-off assembly.
Pump handle is difficult to operate.	<ol style="list-style-type: none"> 1. Swollen or damaged pump piston o-ring. (# 38) 2. Dirty, dry or damaged grommet (#38). 	<ol style="list-style-type: none"> 1. Clean and lubricate or replace o-ring as described in <i>Servicing</i> section. 2. Clean and lubricate hole in grommet or replace grommet as described in <i>Servicing</i> section.
Nozzle drips when shut-off handle is released.	<ol style="list-style-type: none"> 1. Dirt or debris in shut-off valve 2. Damaged o-ring or seal in shut-off (# 38) 	<ol style="list-style-type: none"> 1. Clean shut-off as described in <i>Shut-off Maintenance</i> section. 2. Service shut-off as described in <i>Maintenance service kit# 38</i>.
Nozzle tip leaks, poor spray pattern, partial spray or complete stoppage.	<ol style="list-style-type: none"> 1. O-ring is missing or damaged. 2. Spray extension or nozzle clogged. 	<ol style="list-style-type: none"> 1. Replace o-ring at extension tip (# 23). 2. Remove nozzle and clean as described in <i>Nozzle Maintenance</i> section.

KITS, PARTS & ACCESSORIES



KEY#	PART#	DESCRIPTION
1	181635	DRIVE SUPPORT SHROUD
2	181636	PUMP HOSE BARB
3	181637	PUMP NUT
4	171443	RESERVOIR / CHAMBER
5	181641	PIVOT CLIP
6	181673	HITCH PIN
7	181644	DRIVE SHAFT
8	181643	DRIVE LEVER
9	181645	DRIVE LEVER SCREW (2)
10	181648	BACK HANDLE
11	181529	SELF TAPPING SCREW (6)
12	181687	HOSE CLAMP
13	181649	SHROUD ROD
14	181650	SHROUD SPACER, (2)
15	181651	SHROUD SCREW, (2)
16	181684	SHROUD WASHER, (2)
17	181669	PUMP PISTON
18	181665	STANDARD AGITATOR
19	181117	PUMP

KEY#	PART#	DESCRIPTION
20	181472	SHUT OFF, SMITH PRO (BACKPACK VER.)
21	181545	18" EXT. WAND, POLY, VITON
22	180344	ADJUSTABLE BRASS NOZZLE
23	171092V	VITON O-RING
24	178067	NOZZLE RETAINER NUT
25	181349	SPRAY OPTIMIZER
26	181642	CONNECTING ROD
27	181652	CAP NUT
28	181653	LEFT BUSHING
29	181654	RIGHT BUSHING
30	171015	CHECK VALVE
31	171093	THREE NOZZLE BOOM
32	176455	ADAPTER
33	171084	5-FOOT LANCE
34	171071	TWIN NOZZLE BOOM
35	171085	WEED SHIELD
36	181659	SHOULDER HARNESS
37	181716	SELF TAPPING SCREW (2)

KEY#	PART#	DESCRIPTION	PARTS
38	181698	Maintenance Service Kit Smith Pro Shut-off	Seal Filter O-Ring, Valve Body O-Ring, Viton Nozzle, Brass, Adjustable
		Maintenance Service Kit BackPack	Check Valve Grommet O-Ring, Viton O-Ring, Viton Gasket, Pump O-Ring, Viton
39	181700	Tank Assembly	Tank & Foot Stand
40	181699	Pump Handle Assembly	Pump Handle & Grip
41	181701	Foaming Nozzle Kit	Nozzle, Foaming, Two Piece Nozzle Retaining Nut
42	178070	Fan Tip Set	High Volume Fan Tip Red Nozzle Retaining Nut
43	181564	Filter Basket Assembly	Filter Basket Gasket, Filter Basket
44	181446	Cap Assembly	Tank Cap Check Valve

IMPORTANT:

KEY# 32 is required to adapt the nozzle booms, lance or weed shield to the supplied extension.

SERVICE KITS, PARTS & ACCESSORIES ARE AVAILABLE BY CONTACTING

The Fountainhead Group, Inc. - Customer Service Center

Monday - Friday 8 a.m. - 5 p.m., EST

Toll Free: 1-800-311-9903

or

e-mail: Info@TheFGI.com

or

Access online at: www.TheFountainheadGroup.com